

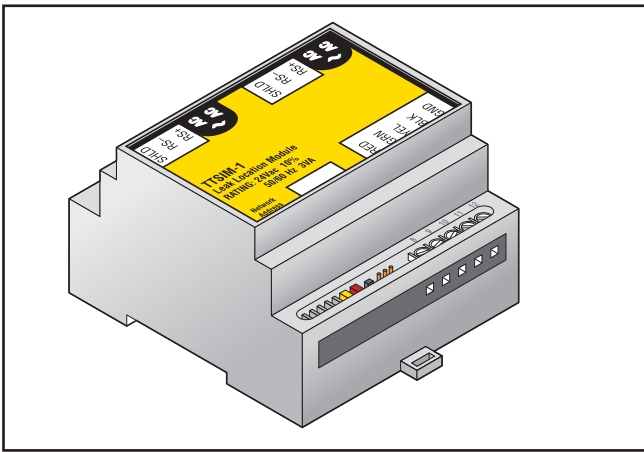

RAYCHEM
TraceTek

TTSIM-1

Sensor Interface Module Installation/Operation Instructions



GENERAL INFORMATION

Please read these instructions and keep them in a safe place. These instructions must be followed carefully to ensure proper operation.

The nVent RAYCHEM TTSIM-1 has been designed for use with nVent RAYCHEM TraceTek sensing cables, point sensors and normally open, dry contact devices (float switch, pressure or vacuum switch, optical probe with adapter, limit switch, etc.). Up to 1500 M (5000 feet) of sensor cable can be monitored by the TTSIM-1 (contact factory for information regarding longer monitoring distance).

The TTSIM-1 is designed for installation in ordinary (nonhazardous) areas. The TTSIM-1 requires 24 Vac 50/60 Hz, 12 Vdc or 24 Vdc to operate and this voltage can be supplied either locally or through the same four wire jumper cable used for communication.

The TTSIM-1 has five small LED's to indicate power, status and communications activity but no other user readout or interface. All alarm and monitoring functions are analyzed and displayed either at a nVent RAYCHEM TTDM-128 alarm and control panel, computer, or at the operator console of a Building or Factory Automation System.

TOOLS REQUIRED

- Small flat blade screwdriver
- Small needle nose pliers
- Tools to mount DIN rail or enclosure

INSTALLATION ITEMS (NOT SUPPLIED)

- 35 mm DIN rail mounting strip (for wall mounts or interior of large control cabinets) and attachment hardware.
- nVent RAYCHEM TT-RS485 power and telemetry jumper cable.
- Optional TTSIM-ENC-4X-Outdoors environmental enclosure for outdoor or corrosive environments, or TTSIM-ENC-4X-Indoors for indoor, non-corrosive environments.

STORAGE

Keep the TTSIM-1 modules in a dry place prior to installation. Avoid damage to components.

ADDITIONAL ITEMS

An agency-approved zener barrier must be used where sensing cable connected to the TTSIM-1 will be located in Class1 Div 1 (Zone 0 or Zone 1 in Europe) Hazardous Locations.

APPROVALS AND CERTIFICATIONS

TYPE NM



General Signaling Equipment
76LJ



REG.-Nr. 1290



Only AC versions are UL listed and VDE Certified.
For DC models use a Listed Class 2 Power Supply.

PRODUCT INFORMATION

TTSIM-1	24 Vac $\pm 10\%$ (22 to 26 Vac) 50/60 Hz
TTSIM-1-12VDC	12 Vdc $\pm 10\%$ 24 Vdc $\pm 10\%$
TTSIM-1-24VDC	24 Vdc $\pm 10\%$

Power consumption 3 VA (3 watts); 2W for DC versions

Installation categories Overvoltage Category II
Pollution Degree 2

Storage temperature -18°C to 60°C (0°F to 140°F)

Operating temperature 0°C to 50°C (32°F to 122°F)

Enclosure NEMA 1; IP20 (NEMA 4X / IP 56 with optional enclosure)

INSTALLING THE TTSIM-1

Note: To avoid damage to the TTSIM-1, store the unit in its packaging until ready to install.

SELECTING THE MOUNTING POSITION

Choose a location where the module will be protected from the elements, temperature extremes or vibration. The TTSIM-1 is designed to be snapped onto standard 35 mm DIN rail. Existing electrical or instrumentation cabinets with spare rail space make good mounting locations. It is also possible to install a small section of DIN rail directly on a wall or cabinet surface and mount the TTSIM-1 in any location as long as it does not create a tripping hazard or expose the TTSIM-1 to impact damage. The TTSIM-1 should be mounted within 1200 m (4000 feet) wire run from the controlling TTDM-128 or control system host. (Contact the factory for methods to increase the wire run distance beyond 1200 m).

IMPORTANT: The TTSIM-1 is an electronic unit. Take the following precautions to avoid damage to electronic components:

- Handle with care, avoid mechanical shock and impact.
- Keep dry.
- Avoid exposure to static electricity by touching a nearby piece of grounded equipment or water pipe prior to handling the TTSIM-1.
- Avoid contact with metal filings, grease, pipe dope and other contaminants.

MOUNTING THE TTSIM-1 MODULE (WITHOUT NEMA 4X ENCLOSURE – FIGURE 1)

- Secure a sufficient length of DIN rail to the desired mounting surface, or locate an existing DIN rail with sufficient space to install the TTSIM-1.
- Remove the TTSIM-1 from its packaging and snap onto the DIN rail with the release tab towards the bottom.
- **Note:** When properly oriented, there will be two terminal strips on the top of the module and one on the bottom. See Figure 1.

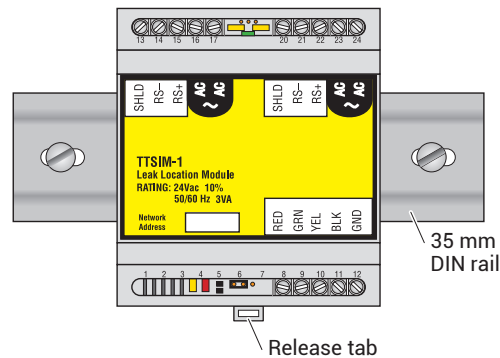

Figure 1. DIN Rail Mount

MOUNTING THE TTSIM-1 MODULE IN THE OPTIONAL NEMA-4X ENCLOSURE – FIGURE 2

- Plan conduit alignment and drill holes as necessary.
- A typical outdoor or harsh environment installation will require up to three holes in the nVent RAYCHEM TraceTek TTSIM-ENC: one for inbound power and telemetry, one for outbound power and telemetry and one for the sensor cable leader. See Figure 2.
- Secure the TTSIM-ENC to any convenient vertical surface using the four corner mounting holes and hardware suitable for the selected surface.
- Rough-in conduit as required and pull the cables for power and telemetry. Leave approximately 20 cm (8 in) for connections to the TTSIM-1 terminals. Pull in the sensor circuit leader cable.
- In order to provide maximum electrostatic discharge protection, and to be CE compliant, the DIN rail must be grounded.

Note: Rough-in and final connections do not have to be completed at the same time, however make sure to replace the cover and tighten the cover screws if the enclosure will be left in a partially installed condition overnight or longer.

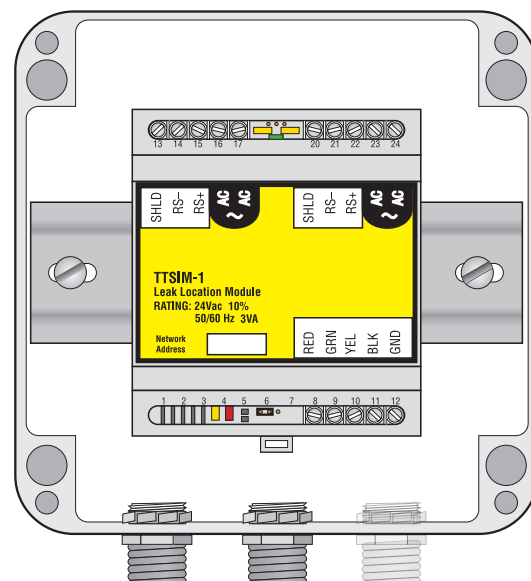

Figure 2. NEMA 4x Enclosure

POWER SUPPLY OPTIONS:

The TTSIM-1 units require 24 Vac $\pm 10\%$ (22 to 26 Vac) 50/60 Hz or 12 Vdc $\pm 10\%$ or 24 Vdc $\pm 10\%$ depending on model selected. In most networks the operating voltage will be supplied from a step down transformer mounted near the TTDM-128 alarm panel or from a DC power supply or from a back-up DC power source provided by the building site. Figure 3 shows typical wiring adequate for any network that will be monitored by a TTDM-128. For very large networks or very long telemetry cable runs, there may be too much voltage drop in the power/telemetry cable to power the entire network from one location. In those situations, a second transformer or DC power source at the distant end of the system may be required. Be sure that each TTSIM-1 receives operating voltage from one and only one source.

IMPORTANT: Observe polarity for 12 Vdc or 24 Vdc power options.

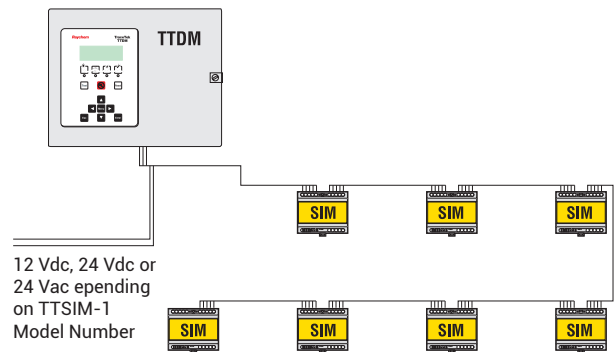

Figure 3. Power Supply to TTSIM units

CONNECTIONS FOR POWER AND TELEMETRY

TTSIM-1 communicates all alarm and status messages via RS-485 twisted pair shielded telemetry. Two of the four conductors in the power/telemetry cable are used for telemetry and the other two wires are used to supply the operating voltage. For all TTSIM-1 modules except the last one, there will be an incoming cable (from the TTDM-128 or other host system) and an outgoing cable (to the next TTSIM-1).

- Use only TraceTek TT-RS485 telemetry cable (Belden 8722) or equal.
- Strip a sufficient amount of the jacket insulation and shielding to expose about 2.5 cm (1 in) of the four wires.
- Strip the primary wires to expose approximately 6 mm (1/4 in) of conductor and make the following connections: (see Figure 4)

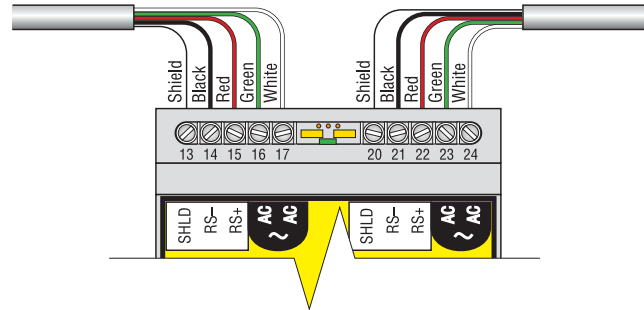

Figure 4. Power and Telemetry Connections

Terminal	Color	Item
13	–	Shield Drain Wire
14	Black	RS-485 (-)
15	Red	RS-485 (+)
16	Green	24 Vac (no polarity), 12 Vdc + or 24 Vdc + (observe polarity of DC supply)
17	White	24 Vac (no polarity), 12 Vdc – or 24 Vdc – (observe polarity of DC supply)
20	–	Shield Drain Wire
21	Black	RS-485 (-)
22	Red	RS-485 (+)
23	Green	24 Vac (no polarity), 12 Vdc + or 24 Vdc + (observe polarity of DC supply)
24	White	24 Vac (no polarity), 12 Vdc – or 24 Vdc – (observe polarity of DC supply)

PLACE THE END OF LINE JUMPER IN THE CORRECT POSITION:

If the TTSIM-1 will be connected to a host for communication, it is necessary to set the End of Line Jumper in the correct position as follows:

- On the last TTSIM-1 in the circuit, place the jumper as shown in Figure 5a.
- On all other TTSIM's in the circuit, place the jumper as shown in Figure 5b.

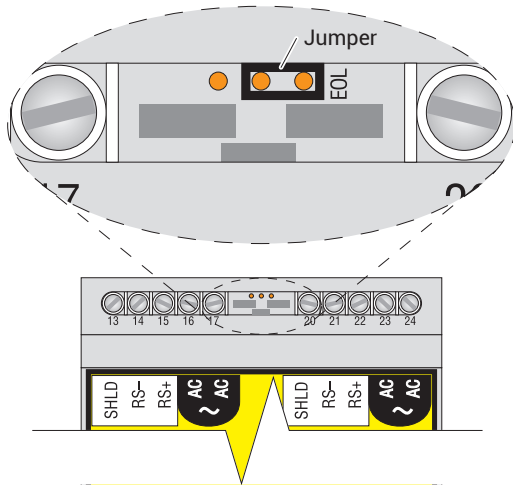

Figure 5a. End of Line Jumper for last TTSIM-1

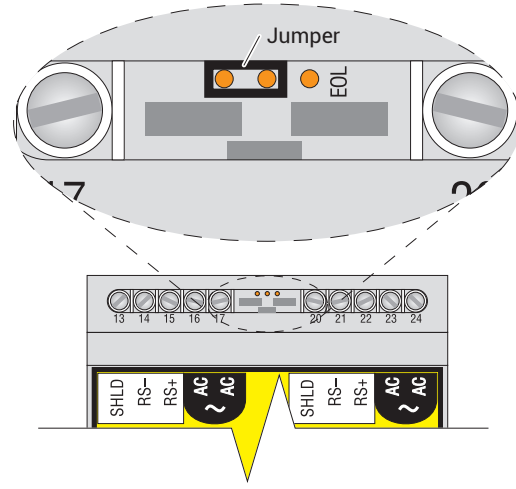

Figure 5b. End of Line Jumper for all other TTSIM's

LEADER CABLE CONNECTIONS FOR SENSOR

The TTSIM-1 can be used with most of the TraceTek family of sensors including: nVent RAYCHEM TT1000, TT3000, TT5000 and TT5001 cables. Connect the TraceTek leader cable to the TTSIM-1 as shown in Figure 6.

Terminal	Color	Item
8	Red	Red / Green Sensor Cable Loop
9	Grn	
10	Yel	Yellow /Black Sensor Cable Loop
11	Blk	
12	-	For diagnostic use only

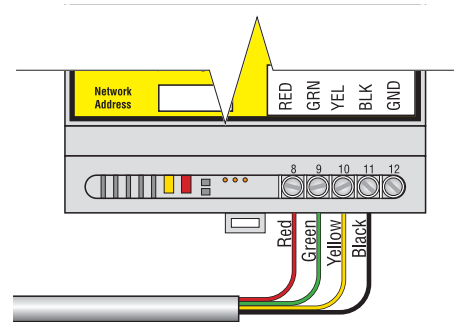

Figure 6. Sensing Cable Connections

NETWORK ADDRESS ASSIGNMENT

Each TTSIM-1 in a TraceTek network must have a unique address in the range 001 to 127. The SIM board built into the TTDM-128 is factory assigned address 001. All external TTSIM-1 units are shipped from the factory with their network address pre-set to a value above the range of valid addresses, in order to prevent communications conflicts during system startup and configuration. Each TTSIM-1 must therefore be configured to its unique address before it can communicate with the TTDM-128 or other host.

To set the TTSIM-1 network addresses, repeat the following procedure for each TTSIM-1. Perform the complete procedure one module at a time:

- Place the TTSIM-1 configuration jumper in the CFG position, as shown in Figure 7a.
- Using the TTDM-128 or host system, assign the new TTSIM-1 address (refer to the TTDM-128 User Manual, H56853).
- Place the configuration jumper in the normal operating position, as shown in Figure 7b, or remove it completely (the jumper is not required in normal operation).
- Write the address in the space provided on the TTSIM-1 cover.

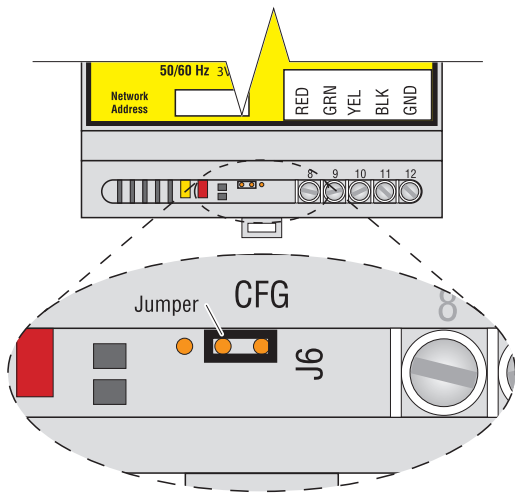

Figure 7a. Configuration Jumper in Configuration Position

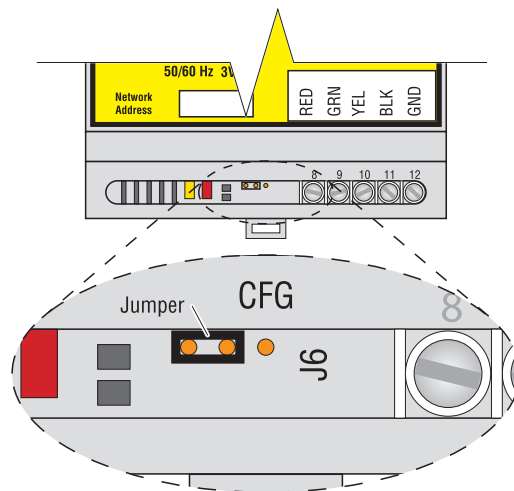

Figure 7b. Configuration Jumper Set for Normal Operation

TTSIM-1 RESET

In the event that the TTSIM-1 appears to be hung-up and unresponsive to the network it is possible to force a RESET. To force a RESET of the TTSIM-1 processor, use a small flat blade screwdriver to momentarily short the pads shown in Figure 8.

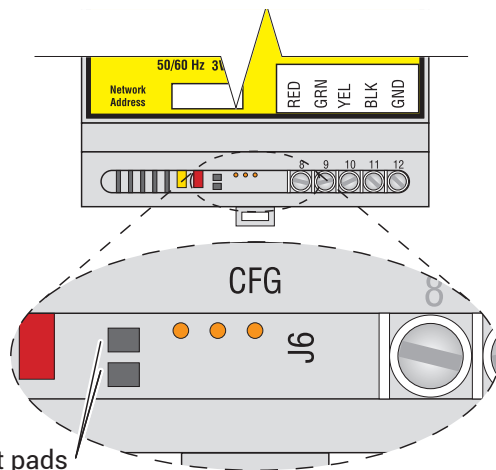

Figure 8. Reset Pads

MAINTENANCE AND TROUBLESHOOTING

No user maintenance is required! There are no user adjustments or calibrations that can be performed in the field.

Each TTSIM-1 is tested and calibrated in the factory during production. An operating TTSIM-1 runs a continuous self check routine and reports any discrepancies to the TTDM-128 host

computer. If the TTSIM-1 or the network wiring fails in such a way that the TTSIM-1 cannot communicate with the host, then the host reports the failure as a communications failure.

STATUS INDICATORS

There are 5 LED's on the TTSIM-1 circuit board to indicate: operating power, communications (RX = inbound and TX = outbound), sensor status (leak detected and trouble). See Figure 9 for locations and colors.

Table 1 indicates various status conditions and possible corrective actions:

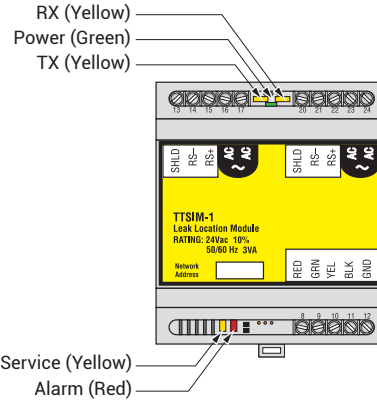

Figure 9. TTSIM-1 LED Locations

Table 1. TTSIM-1 LED Status Indications

POWER	TX	RX	ALARM	SERVICE	INDICATION
OFF	OFF	OFF	OFF	OFF	No power to unit. Check wiring, connections and power supply. Measure voltage at terminals 16 and 17. Should be 24 Vac, 12 Vdc, or 24 Vdc, ±10%.
ON	FLASHING	FLASHING	SLOW FLASH	OFF	Normal Operation. No alarms or service requests. Alarm LED flashes once every 5 seconds to indicate normal operation.
ON	FLASHING	FLASHING	ON	OFF	Leak detected by sensor. Check sensor being monitored for leak or spill.
ON	FLASHING	FLASHING	OFF	FLASHING	Unit has detected a condition requiring outside attention. The flash sequence indicates the type of condition: 1 Flash Sensor cable break 2 Flashes Sensor cable loop imbalance 3 Flashes EPROM hardware error 10 Flashes Sensor cable contamination
ON	OFF	FLASHING	SLOW FLASH	OFF	Unit is not responding to TTDM-128 or host. Re-initialize the SIM network on the TTDM-128 (or host), and check the TTSIM-1 address.
ON	OFF	OFF	OFF	OFF	Unit not receiving any communication from TTDM-128 or host. Check network master unit and telemetry wiring and connections.

North America

Tel +1.800.545.6258
Fax +1.800.527.5703
thermal.info@nvent.com

Europe, Middle East, Africa

Tel +32.16.213.511
Fax +32.16.213.604
thermal.info@nvent.com

Asia Pacific

Tel +86.21.2412.1688
Fax +86.21.5426.3167
cn.thermal.info@nvent.com

Latin America

Tel +1.713.868.4800
Fax +1.713.868.2333
thermal.info@nvent.com



nVent.com